



HR





Fontenay-sur-Eure



Carvin



Châteaubourg



La Conillais



Osasco





**WE ARE** energetic  
PRECISION **ARE** efficiency  
**INDUSTRIAL**  
TECHNOLOGY

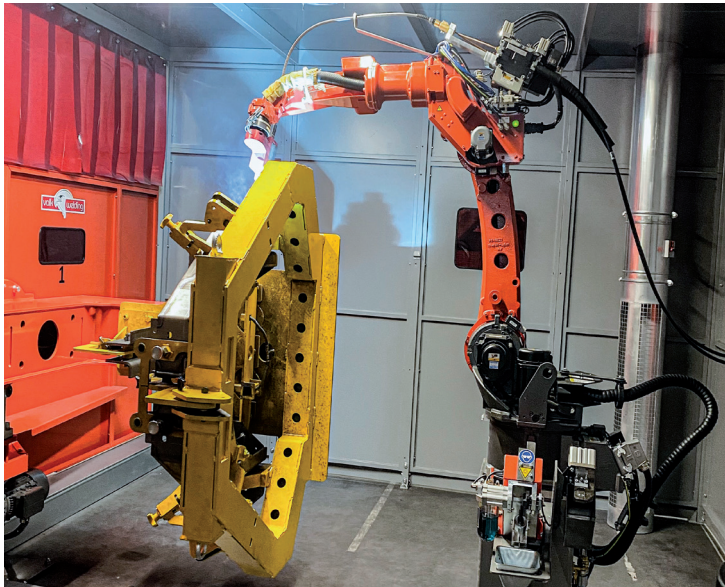



# FARMING TOGETHER

Be positive about Agriculture

*Positez sur l'Agriculture*

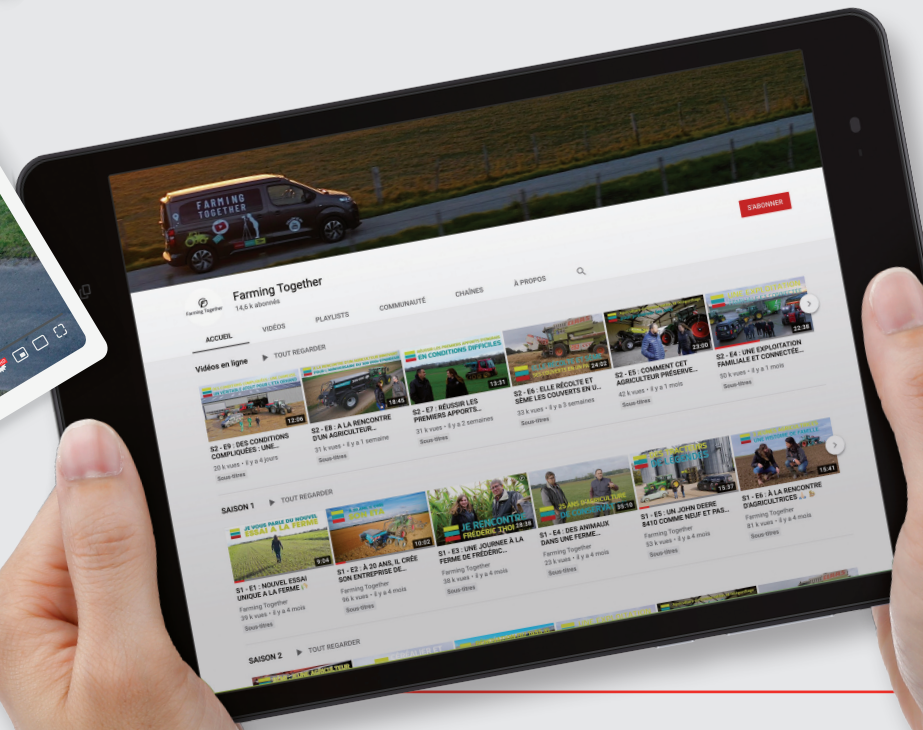
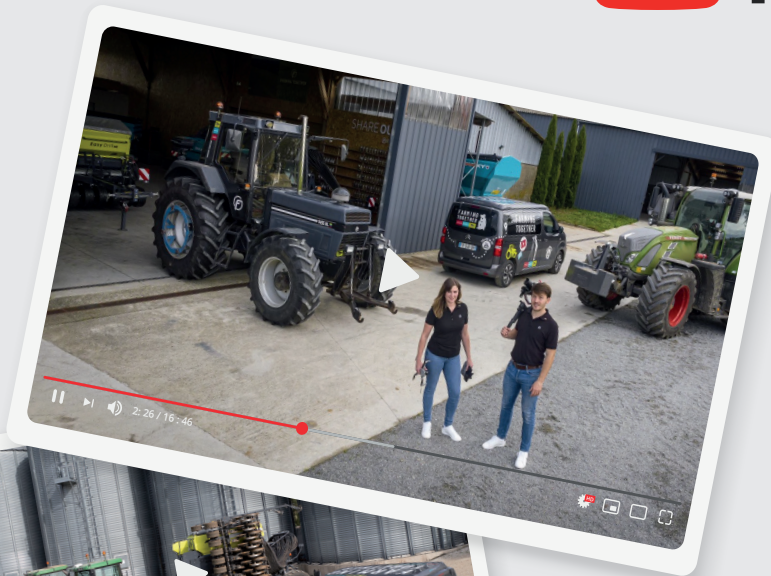



Softshell



Veste matelassée



[farming-together.com](https://farming-together.com)

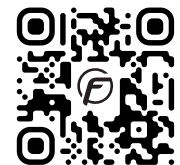





# HR

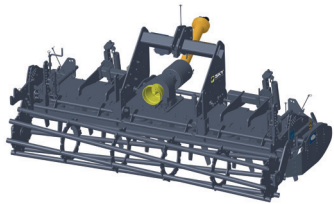

**HR 160 / 3m**

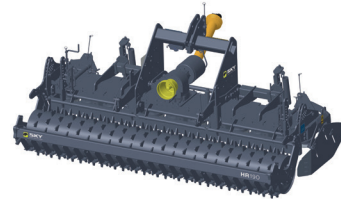

**HR 190 / 3m**

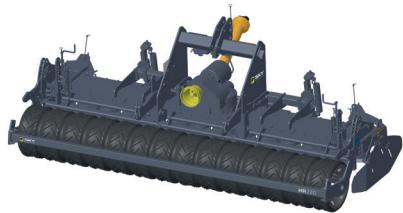

**HR 220 / 3,5 - 4m**

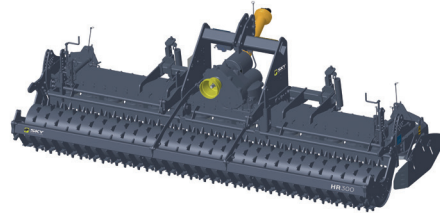

**HR 300 / 3 - 3,5 - 4m**

# HRW

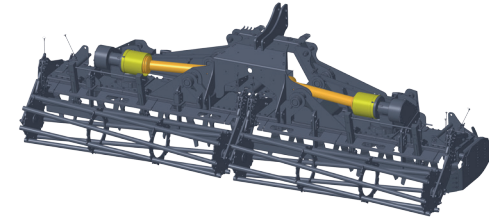

**HRWS280 / 4 - 4,5 - 5 - 6m**

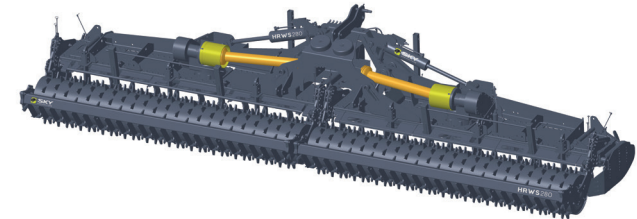

**HRW280 / 4 - 4,5 - 5 - 6m**

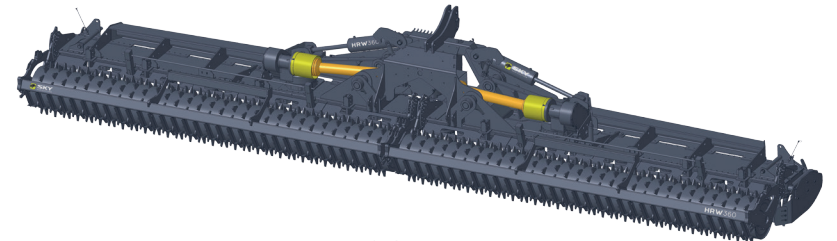

**HRW360 / 6 - 7 - 8m**



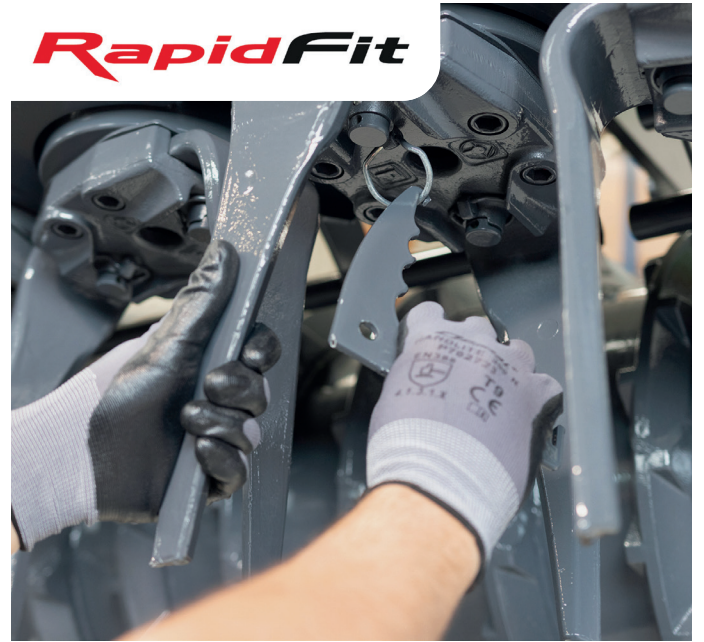
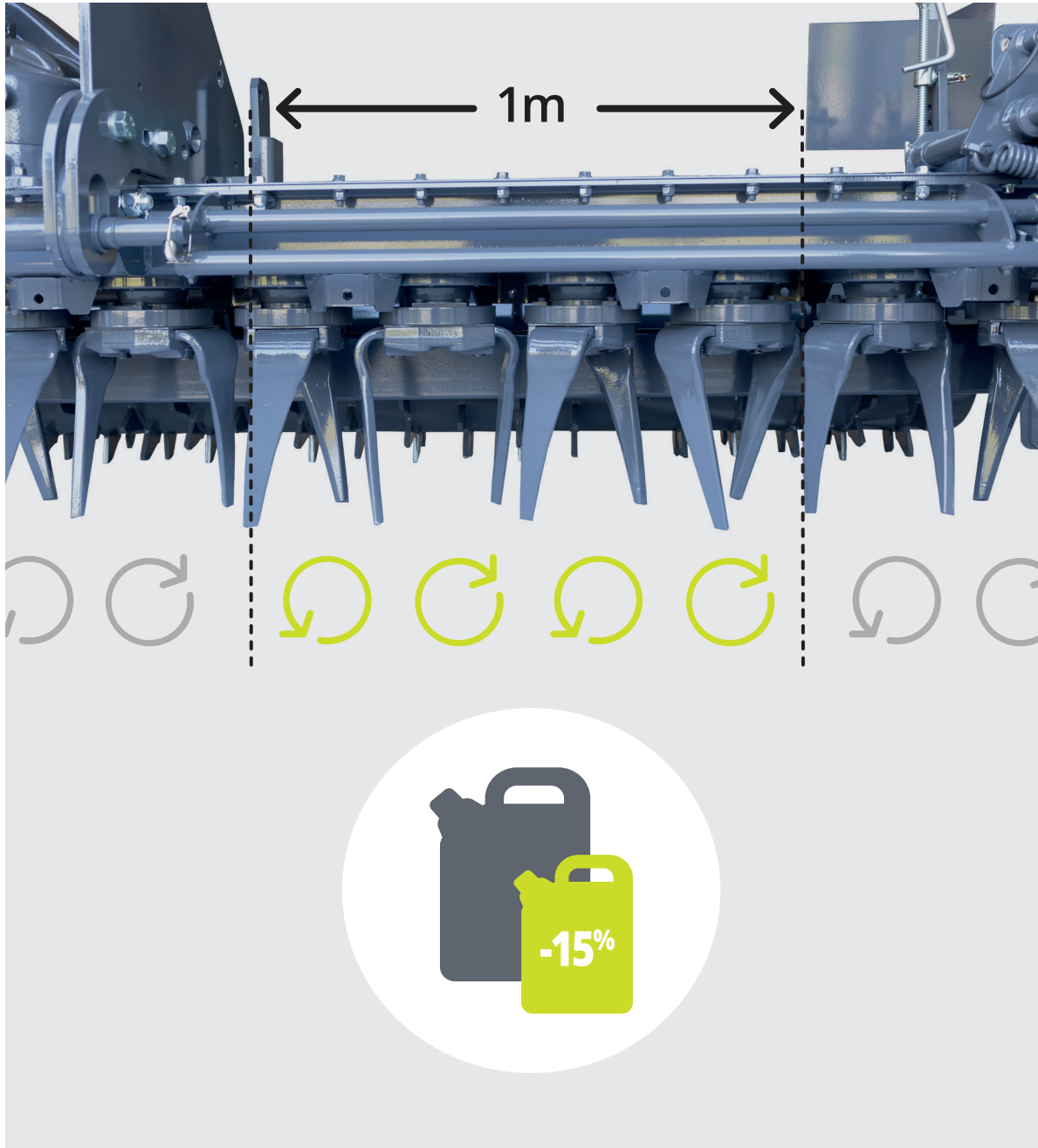



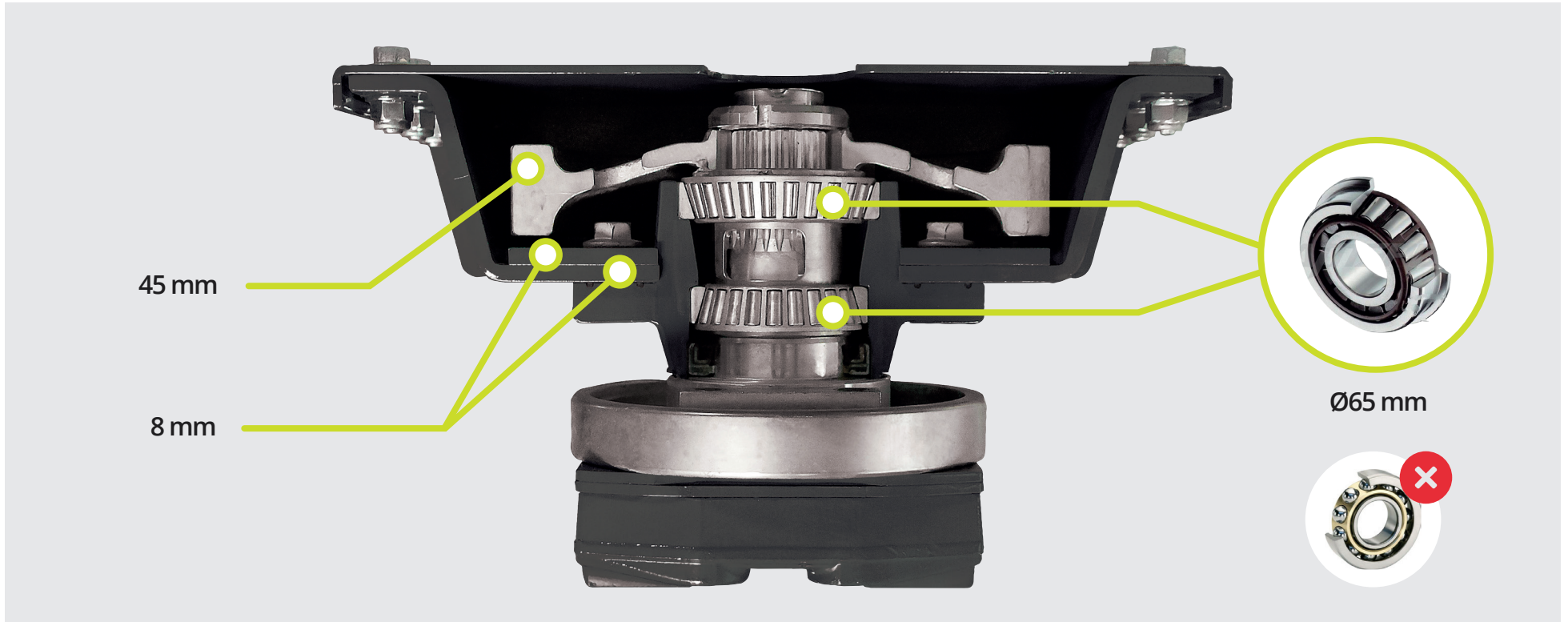



**Cage**  
Ø500 mm

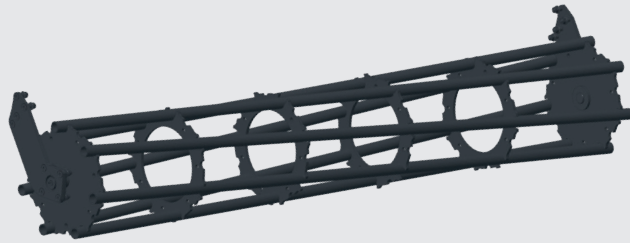

**Farmflex**  
Ø520 mm



**Packer**  
Ø550 mm

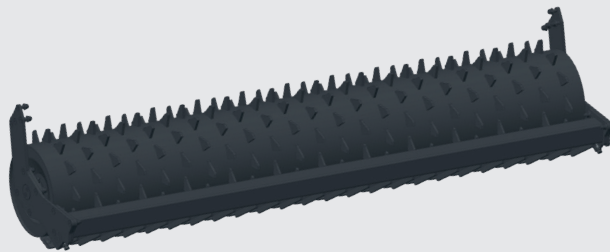

**Tracker**  
Ø550 mm



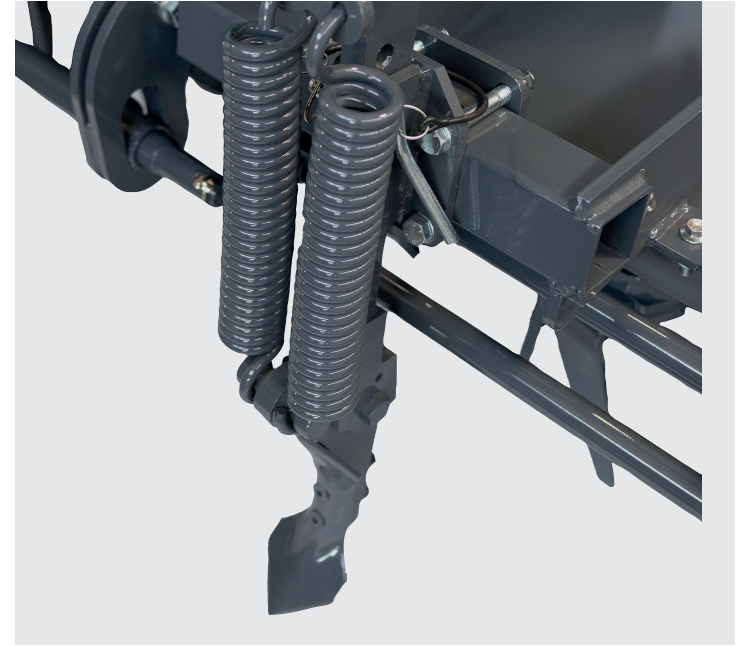
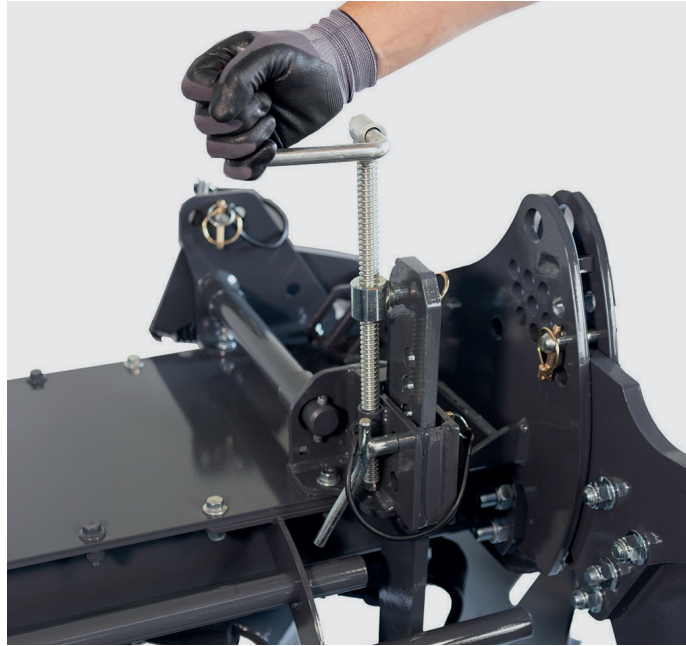







# HR

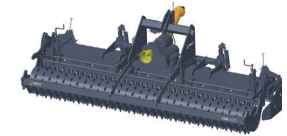
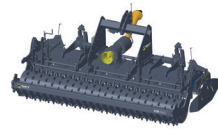
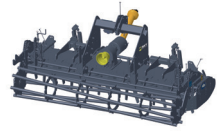

|                     | HR 160 |  |  |  | HR 190 |  | HR 220 |      | HR 300 |      |      |
|---------------------|--------|--|--|--|--------|--|--------|------|--------|------|------|
| (kg)<br>Packer Ø550 | 1408   |  |  |  | 1700   |  | 1857   | 2041 | 1734   | 1937 | 2120 |
| (m)                 | 3      |  |  |  | 3      |  | 3,5    | 4    | 3      | 3,5  | 4    |
| (m)                 | -      |  |  |  | -      |  | -      | -    | -      | -    | -    |
| (CV)                | 160    |  |  |  | 190    |  | 220    |      | 300    |      |      |
|                     | 12     |  |  |  | 12     |  | 14     | 16   | 12     | 14   | 16   |

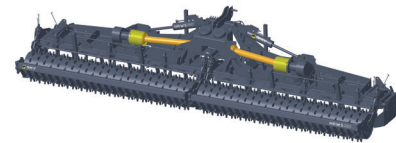
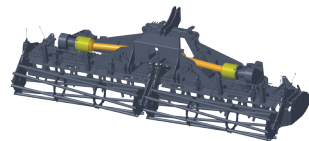

# HRW

|                     | HRWS 280 |      |      |      | HRW 280 |      |      |      | HRW 360 |      |      |  |
|---------------------|----------|------|------|------|---------|------|------|------|---------|------|------|--|
| (kg)<br>Packer Ø550 | 2570     | 2780 | 2990 | 3410 | 2770    | 2980 | 3190 | 3610 | 3710    | 4130 | 4550 |  |
| (m)                 | 4        | 4,5  | 5    | 6    | 4       | 4,5  | 5    | 6    | 6       | 7    | 8    |  |
| (m)                 | 2,5      | 2,5  | 2,5  | 2,5  | 2,95    | 2,95 | 2,95 | 2,95 | 2,95    | 2,95 | 2,95 |  |
| (CV)                | 280      |      |      |      | 280     |      |      |      | 360     |      |      |  |
|                     | 16       | 18   | 20   | 24   | 16      | 18   | 20   | 24   | 24      | 28   | 32   |  |

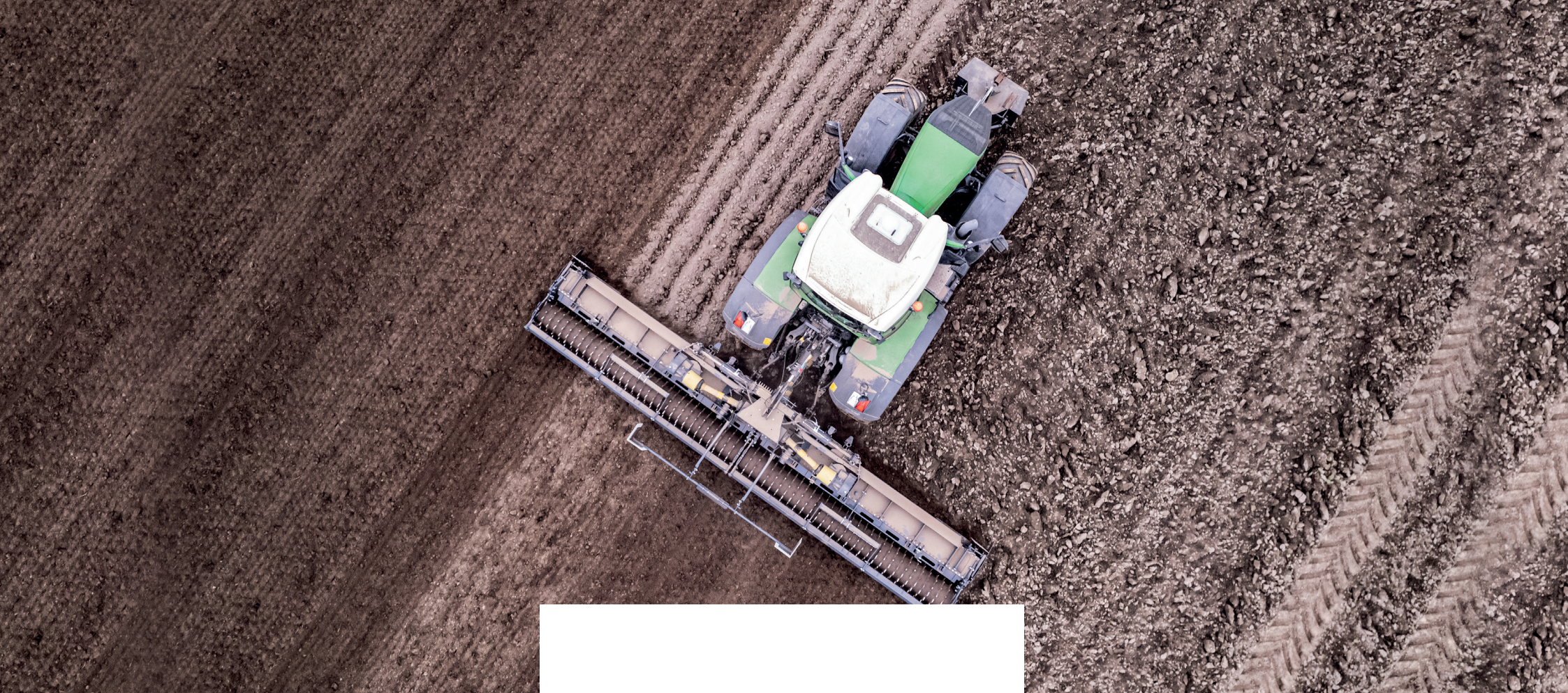

### **Châteaubourg**

P.A. de la Gaultière  
35220 Châteaubourg

### **Fontenay**

21 Rue Jean Monnet  
28630 Fontenay-sur-Eure

### **Carvin**

Rue du Pont de Grès  
62220 Carvin

### **Osasco**

Via Garzigliana, 37  
10060 Osasco TO, Italie

### **Ferme de la Conillais**

Saint-Émilien-de-Blain  
44130 Blain

 Tél : +33 (0)2 99 00 84 84

 [contact@sky-agriculture.com](mailto:contact@sky-agriculture.com)

 [sky-agriculture.com](http://sky-agriculture.com)